

CRYSTAL CONTROLLED OSCILLATORS

SURFACE MOUNT 3.3V LVCMOS STRATUM 3 OCXO

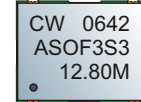

ASOF3S3

ABSOLUTE MAXIMUM RATINGS

TABLE 1.0

PARAMETER	UNITS	MINIMUM	NOMINAL	MAXIMUM	UNITS	NOTE
Storage Temperature		-55	-	125	°C	
Supply Voltage	(Vcc)	-0.5	-	4.5	Vdc	

OPERATING SPECIFICATIONS

TABLE 2.0

PARAMETER		MINIMUM	NOMINAL	MAXIMUM	UNITS	NOTE
Center Frequency	(Fo)	1.544	-	20.0	MHz	
Frequency Calibration		-1.5	-	1.5	ppm	1,4
Frequency Stability		-0.25	-	0.25	ppm	2
Total Frequency Tolerance		-4.6	-	4.6	ppm	3
Aging (Daily)		-30	-	30	ppb	4
Aging (20 years)		-3.0	-	3.0	ppm	
Operating Temperature Range		0	-	70	°C	
Supply Voltage	(Vcc)	3.135	3.3	3.465	Vdc	
Supply Current	(Icc)	-	-	450	mA	
Phase Jitter (BW =12KHz to 20MHz)		-	-	1	ps RMS	
Phase Jitter (BW =10Hz to 20MHz)		-	-	3	ps RMS	
Period Jitter		-	-	3	ps RMS	
Allan Variance (1 Second)		-	5.00 E-10	-		
SSB Phase Noise at 10Hz offset		-	-90	-	dBc/Hz	
SSB Phase Noise at 10KHz offset		-	-130	-	dBc/Hz	
Start-Up Time: Oscillator		-	-	10	mS	
Warm Up Time		-	-	5	Minutes	5
TDEV at 1.0 seconds		-	-	1	ns	
TDEV at 4.0 seconds		-	-	2	ns	

LVCMOS OUTPUT CHARACTERISTICS

TABLE 3.0

PARAMETER		MINIMUM	NOMINAL	MAXIMUM	UNITS	NOTE
LOAD		-	-	15	pF	
Voltage (High)	(Voh)	2.6	-	-	Vdc	
(Low)	(Vol)	-	-	0.4	Vdc	
Current (High)	(Ioh)	-4	-	-	mA	
(Low)	(Iol)	-	-	4	mA	
Duty Cycle at 50% of Vcc		45	50	55	%	
Rise / Fall Time 10% to 90%		-	-	6	ns	

PACKAGE CHARACTERISTICS

TABLE 4.0

Package	Surface Mount, Non-hermetic package consisting of an FR4 substrate with grounded metal cover.
---------	---

PROCESS RECOMMENDATIONS

TABLE 5.0

Soldering Process	See the solder profile on page 2.
Wash	Ultrasonic cleaning is not recommended

Notes:

- 1) Initial calibration @ 25 C
- 2) Frequency vs. temperature stability
- 3) Inclusive of calibration, operating temperature range, supply voltage change, shock and vibration and aging (20 years).
- 4) Specifications at time of shipment after 48 hours of operation.
- 5) Measured @ 25 C, within 5 minutes, the unit will be within +/-0.1ppm of its reference frequency, measured after 30 minutes of continuous operation at a stable 25 C.

DESCRIPTION

The Connor-Winfield ASOF3S3 is a true Surface Mount 3.3V Oven Controlled Crystal Oscillator (OCXO) with an LVCMOS output. The ASOF3S3 is designed for Stratum 3 applications requiring tight frequency stability and low jitter.

FEATURES

FIXED FREQUENCY OCXO

3.3V OPERATION

LOW JITTER <1ps RMS

FREQUENCY STABILITY: ±0.25ppm

TEMPERATURE RANGE: 0 to 70°C

FREQUENCY TOLERANCE OF ±4.6ppm OVER TWENTY YEARS

SURFACE MOUNT PACKAGE

TAPE AND REEL PACKAGING

RoHS 5/6 COMPLIANT

ORDERING INFORMATION

ASOF3S3 - 12.80MHz

OCXO
SERIES

CENTER
FREQUENCY

Specifications subject to change without notice.



CRYSTAL CONTROLLED OSCILLATORS

ENVIRONMENTAL CHARACTERISTICS

Temperature Cycle: Per MIL-STD-883, Method 1010, Condition B. -55°C to 125°C, 20 cycles, 10 minute dwell, 1 minute transition.

SOLDERING

Pad Solderability: Per MIL-STD-883, Method 200. 8 hour steam age prior to 254°C ±5°C Solder pot dip, 95% Coverage.
Solder Reflow: The component solder internal to this device has a melting point of 221°C, the peak temperature inside the device should be less than or equal to 220°C for a maximum of 10 seconds.

MECHANICAL CHARACTERISTICS

Vibration: Per MIL-STD-202, Method 204, Condition A. 10G's peak, 10Hz to 500Hz, 15 minute cycles 12 times each perpendicular axis.

Shock: Per MIL-STD-202, Method 213, Condition D. 500G's, 1ms, half sine, 3 shocks per direction.

Moisture Resistance: Per MIL-STD-202, Method 106. 95% RH @ 65°C, 10 cycles 10°C to 65°C.

Package Outline

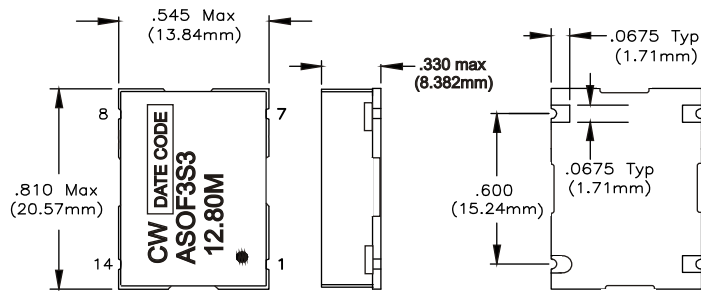

Pin Connections

Pin	Function
1	N/C
7	Ground (Case)
8	Output
14	Vcc

Dimensional Tolerance: ±.005 (.127mm)

Output Waveform

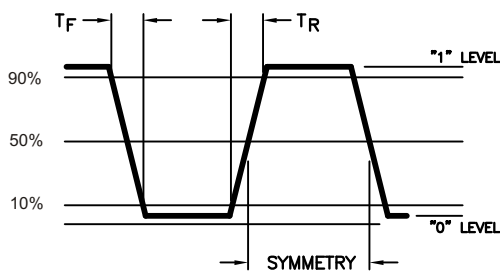

Suggested Pad Layout

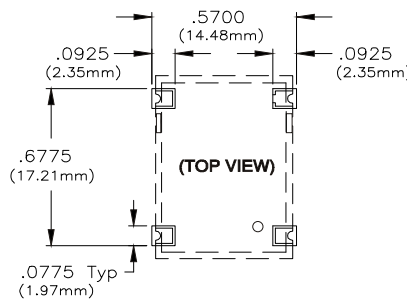

Keep Out Area

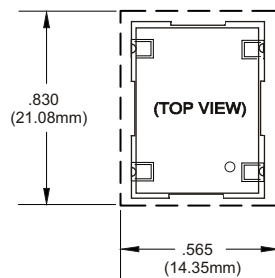

Test Circuit

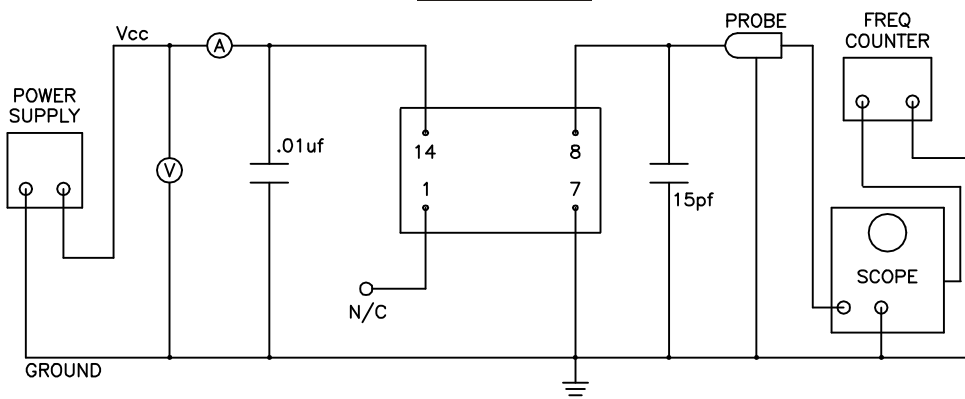

Solder Profile

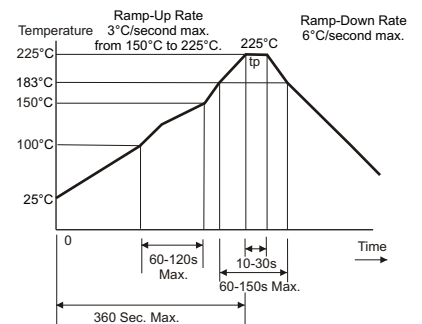

Specifications subject to change without notice.